

Axioskop 2 plus
Axioskop 2 mot plus

Upright Microscopes for the Life Sciences

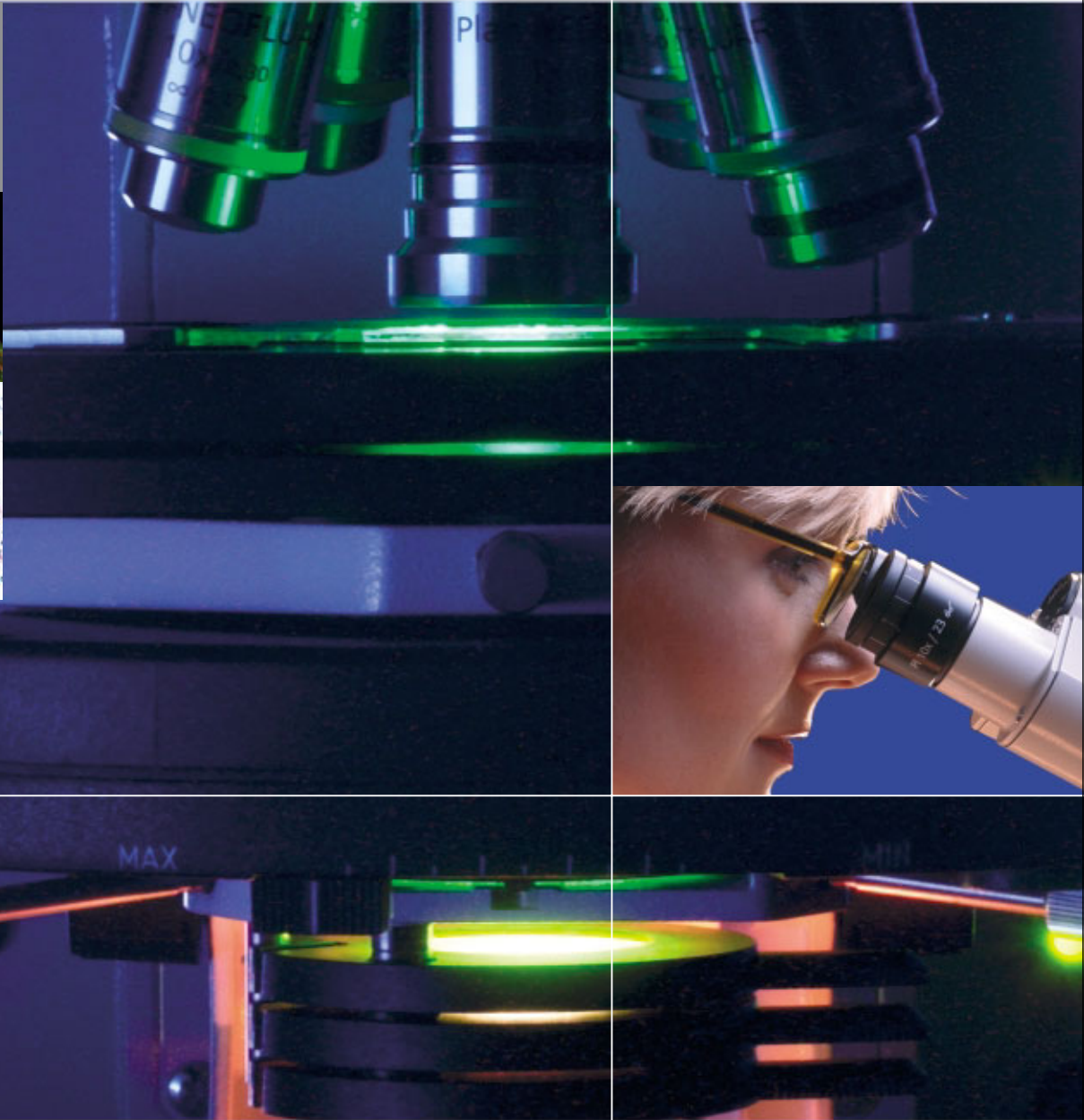

Setting New Standards
in Biology and Medicine

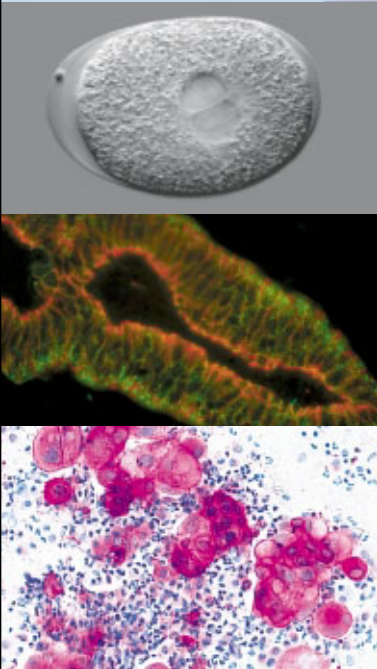

The Standard in Life Science Microscopy

Fast and reliable viewing, analyzing and evaluation of an extensive range of biological specimens: all thanks to the excellent imaging quality of the **Axioskop 2 plus** and **Axioskop 2 mot plus** microscopes.

All the standard microscopy techniques – from transmitted light bright-field to epi-fluorescence – can be used without any restrictions.

Modern image-producing techniques and sophisticated, user-oriented software are also available.

Both microscopes offer unsurpassed versatility and provide numerous features for even greater ease of operation. The motorized **Axioskop 2 mot plus** enables easy reproduction of many functions and is the basis for software-controlled processes.

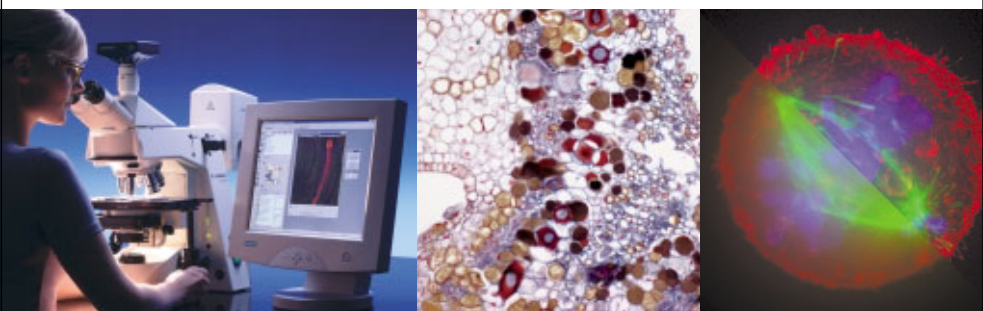

The **Axioskop 2 plus** and **Axioskop 2 mot plus** turn routine daily microscopy into something to look forward to. A choice of manual, coded and motorized components permits user-specific requirements to be met in every detail.

Carl Zeiss milestones.

The history of fluorescence microscopy.

For more than 150 years, Carl Zeiss has been the great name in microscopy, and in fluorescence microscopy for almost 100 years. The company's developments have set milestones – then and now.



1904

Zeiss develops the first ultraviolet microscope. This not only increased resolution, but also permitted fluorescence on crystals to be viewed for the first time.

1936

Zeiss builds the first epi-fluorescence microscope.

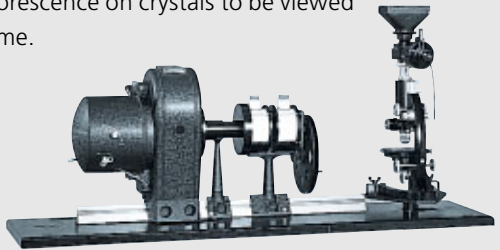

1965

Zeiss designs an epi-fluorescence module for its world-famous Standard series of routine microscopes. This made it possible for the first time to combine epi-fluorescence with transmitted light techniques.



1987

Zeiss introduces the Axioskop with ICS optics (Infinity Color-Corrected System). Special solutions, e.g. for fluorescence applications, were added. This established a leading edge which is unchallenged to this very day.

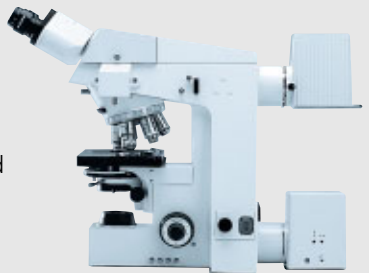

1998

The Axioskop 2 and Axioskop 2 MOT permit the fast, professional and productive performance of simple and complex examinations of biological specimens.

2001

Axioskop 2 plus and Axioskop 2 mot plus.

A wide range of additional options make these microscopes the ideal platform for modern fluorescence applications.

Axioskop 2 plus Axioskop 2 mot plus

For research and routine

The **Axioskop 2 plus** and **Axioskop 2 mot plus** microscopes combine a variety of excellent optical and technologically advanced features.

These high-performance microscopes offer maximum economy for all standard applications in the life sciences.

The modular design permits perfectly tailored configurations to meet any specific requirements. Optimized illumination and contrasting techniques combined with the ICS optics guarantee high image quality.

The ergonomic design of the microscope components and controls ensures fatigue-free operation over long periods of time.

Thanks to the coding and motorization of the **Axioskop 2 mot plus**, reproducible microscope settings are now even more convenient and quicker than before.





Pure Operating Convenience

Properly applied, ergonomic design relieves the mind as well as the body. Daily microscope work over many hours makes a fatigue-free body posture particularly important. Combined with simple, precisely reproducible operations, this ensures perfect results.

However, only the correct interaction of all the major ergonomic components increases productivity.

The **Axioskop 2 plus** and **Axioskop 2 mot plus** microscopes take all these aspects into consideration.

Field of view

The 23 mm field provides an optimum specimen overview without any need for tiring eye movement.

Controls

Easily accessible controls and ergonomically designed microscope details permit a relaxed body posture.

Focusing

Reliable, fast and precise focusing with the Harmonic Drive™ gearbox ensures high focusing speeds and excellent reproducibility.

Viewing

All binocular tubes permit the precise, reproducible setting of the user's specific interpupillary distance. Swinging the eyepieces while retaining the interpupillary distance permits the viewing height to be changed easily by up to 40 mm. Furthermore, the ergonomic tubes provide different viewing heights and angles.

Thanks to eyepieces with folding eyecups, the removal of spectacles during microscopy has become unnecessary.

Microscope stage

The vertically adjustable stage drive is positioned very close to the focusing drive to permit one-handed operation of the microscope stage and focusing drive.



Ergonomic tube





**Relaxed, fatigue-free
and efficient microscopy**

Motorization for Easy Operation

Microscopy is particularly efficient if recurring procedures can be performed simply, quickly and reproducibly.

The **Axioskop 2 mot plus** offers the ideal requirements: coded and motorized microscope components, easily accessible function controls on the stand, and sophisticated operating software.

Coding

The positions of both the quintuple and sextuple nosepieces are coded. The same applies to the five reflector turret positions. Therefore, the operating software knows at all times which magnification and which contrasting technique is being used. The required illumination intensity can thus be activated automatically. All the electronic data of the microscope configuration is transferred to the control and application software. Exact documentation of the microscope settings is guaranteed at all times.

*Motorized focus
via traditional
coarse/fine drive*

Motorized condenser



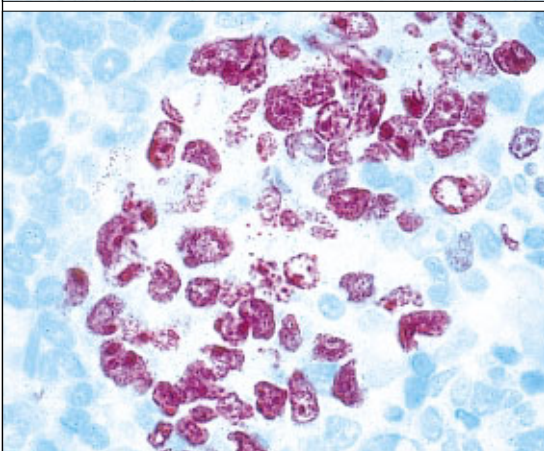
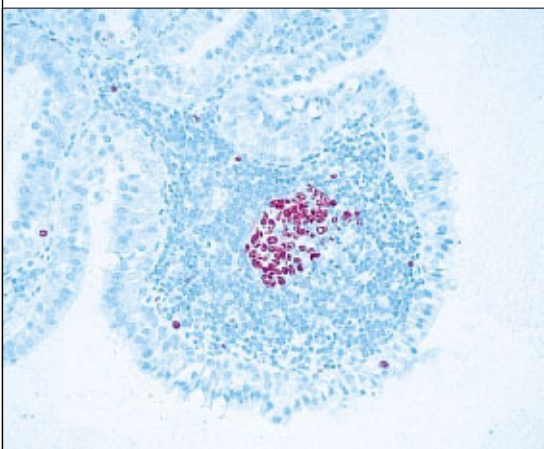
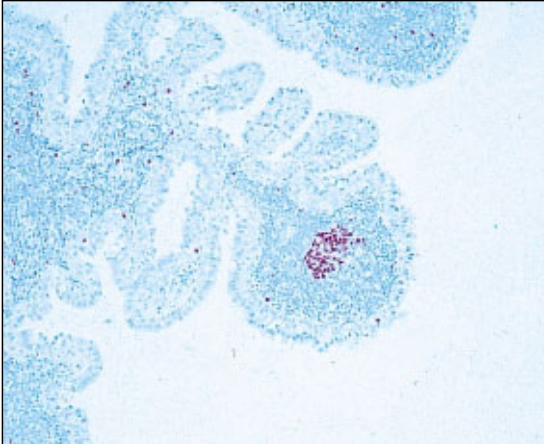

*Cystadenolymphoma,
immunohistochemical staining
of proliferating cells,
brightfield*

Motorization

The **Axioskop 2 mot plus** features one constantly motorized component: the z-drive. Nevertheless, manual operation is also possible – via a traditionally styled coarse / fine drive on both sides of the stand. Increments of 50 nm are ideal for a variety of applications. Of course, motor control with z-position readout is also possible via the software.

The motorized reflector turret permits the change from reflected light to transmitted light and vice versa at the push of a button. The required light intensity is adjusted automatically.

In addition to fluorescence filter sets, the reflector turret also accepts additional magnification optics – Optovar modules – for transmitted light techniques.

The motorized shutter in the reflected-light beam path prevents unnecessary bleaching of the fluorescence dyes. The possibility of integrating shutter functions in the software is particularly beneficial for time-lapse experiments.

Further motorized components include the universal condenser, an external excitation filter wheel and the microscope stage.

Integration of all the motorized components in the application software turns the microscope into a screening system.

*Endothelial cells
of the pulmonary artery,
triple fluorescence*

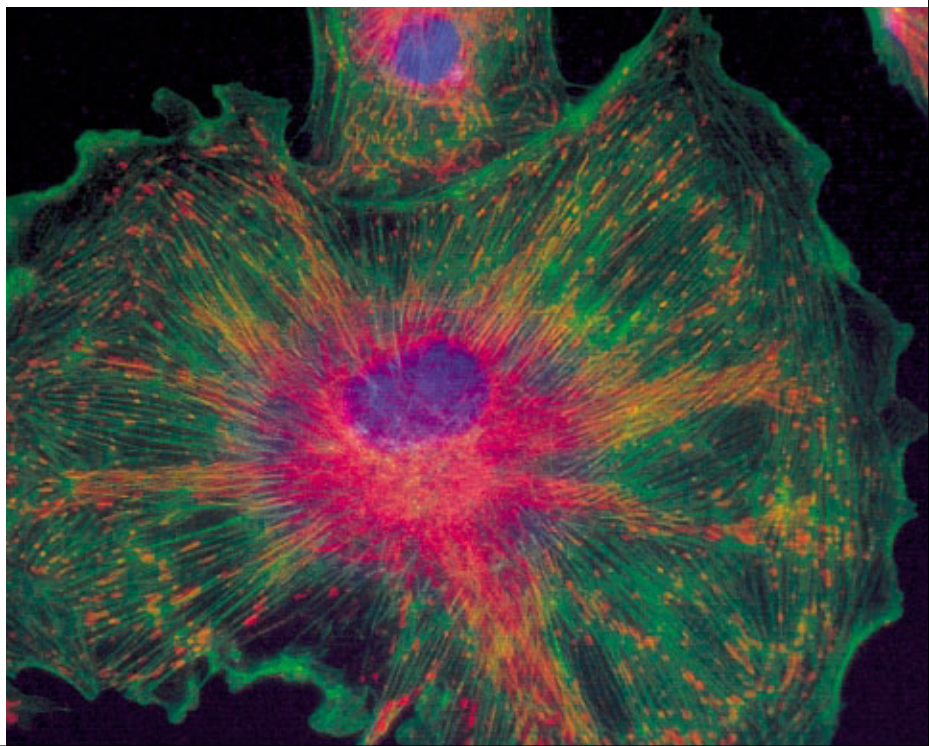

Memory Function

Thanks to the coded and motorized components, all microscope settings are known at all times. This permits the operating software to control all settings in accordance with default values which can be defined as required. For example, the required contrasting technique is automatically set after an objective change: brightfield, phase contrast or DIC, each with the correct condenser aperture and the required light intensity.

Entire microscope configurations can be easily defined, applied and modified.



Fast change of microscope technique

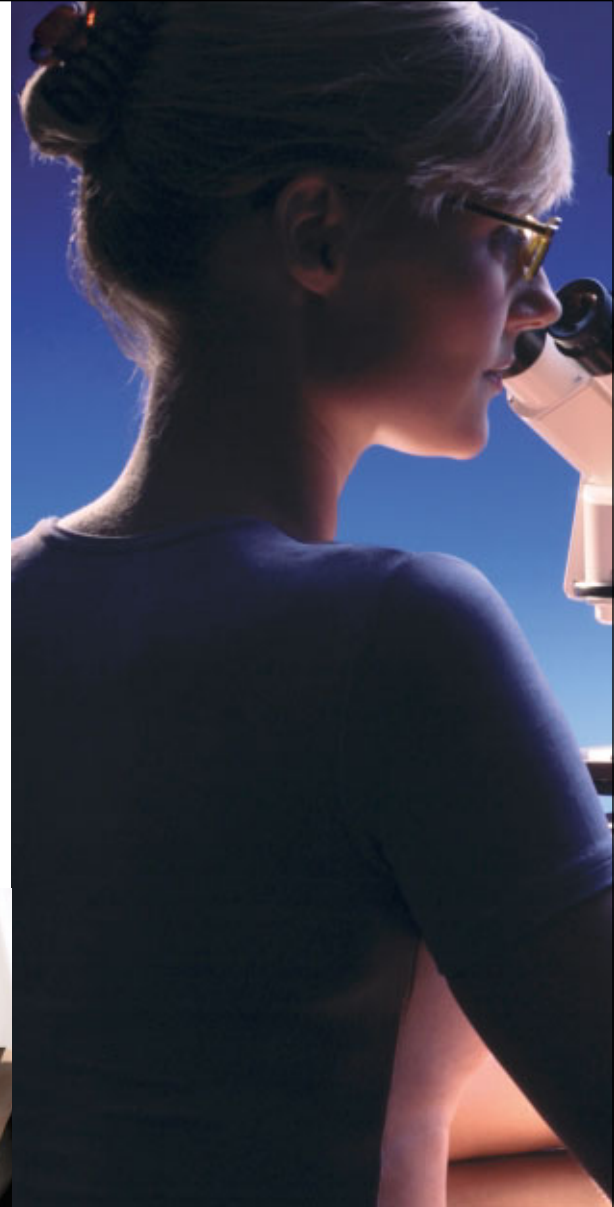

Condenser aperture automatically matched to the objective aperture





*Adenocarcinoma,
immunocytochemical staining
of tumor cells,
brightfield*

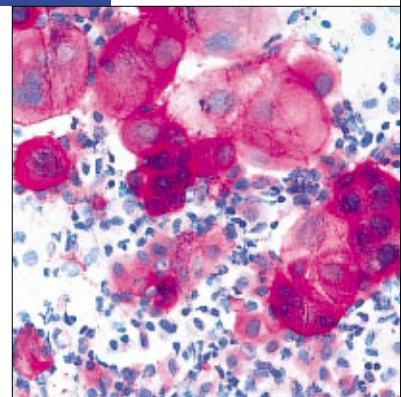
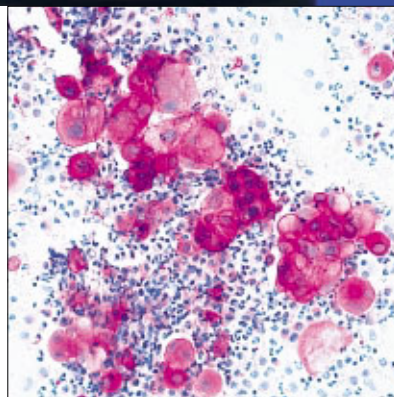
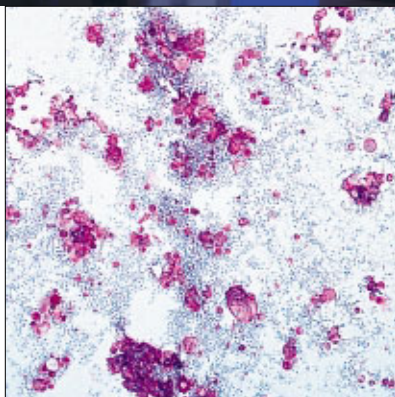

*Tongue,
hematoxylin and eosin staining,
brightfield*

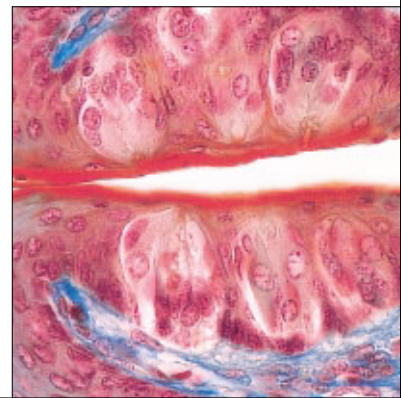
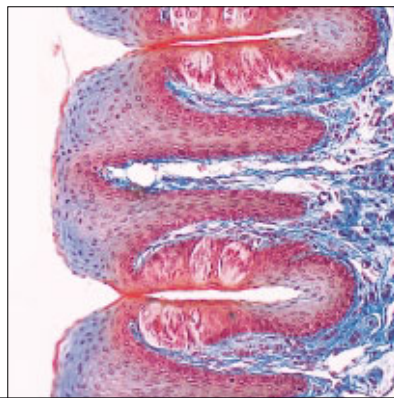
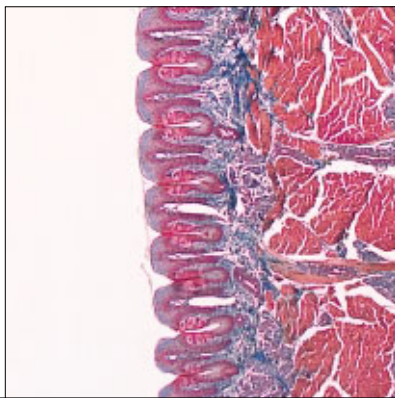

Transmitted Light Microscopy

Traditional microscopy techniques such as brightfield, darkfield, phase contrast, differential interference contrast (DIC) and polarization can be performed without any restriction. The positioning of the DIC analyzer as a module in the reflector turret is particularly beneficial, since turning of the reflector turret permits the fast change from DIC to brightfield or phase contrast. Motorized and coded components make this function extremely convenient.

Brightfield

The traditional microscopy technique for stained histology specimens such as tissue sections and smears.

Darkfield

The contrasting technique for the display of minute structures at or even below the resolution limits of a light microscope.

Phase contrast

Ideal for fine tissue and cell structures in very thin, unstained or only slightly stained specimens.

Polarization

The technique for the display of birefringence features of crystals and biological molecules.

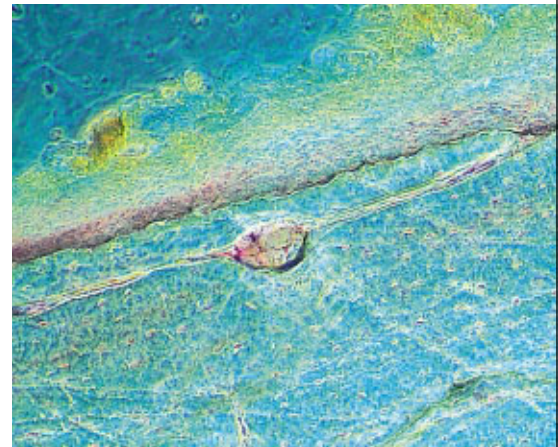
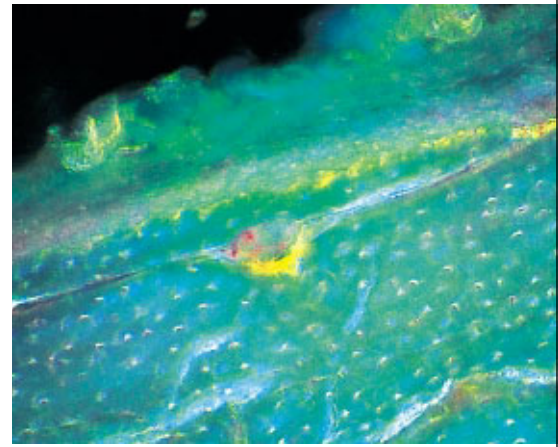
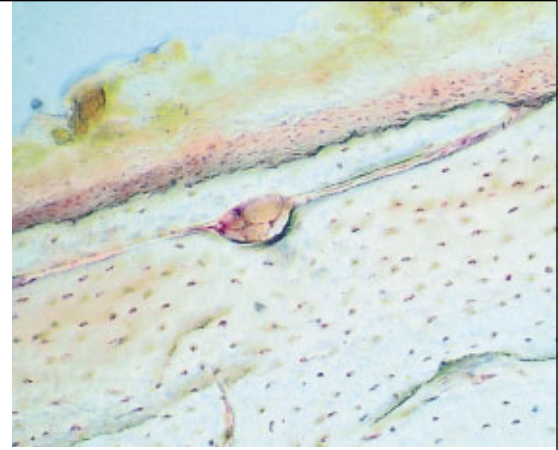

Thin section of bone, brightfield, darkfield, phase contrast

Universal condenser



Arthritis crystal, polarization

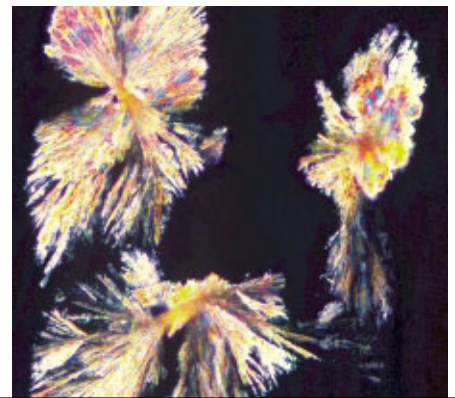

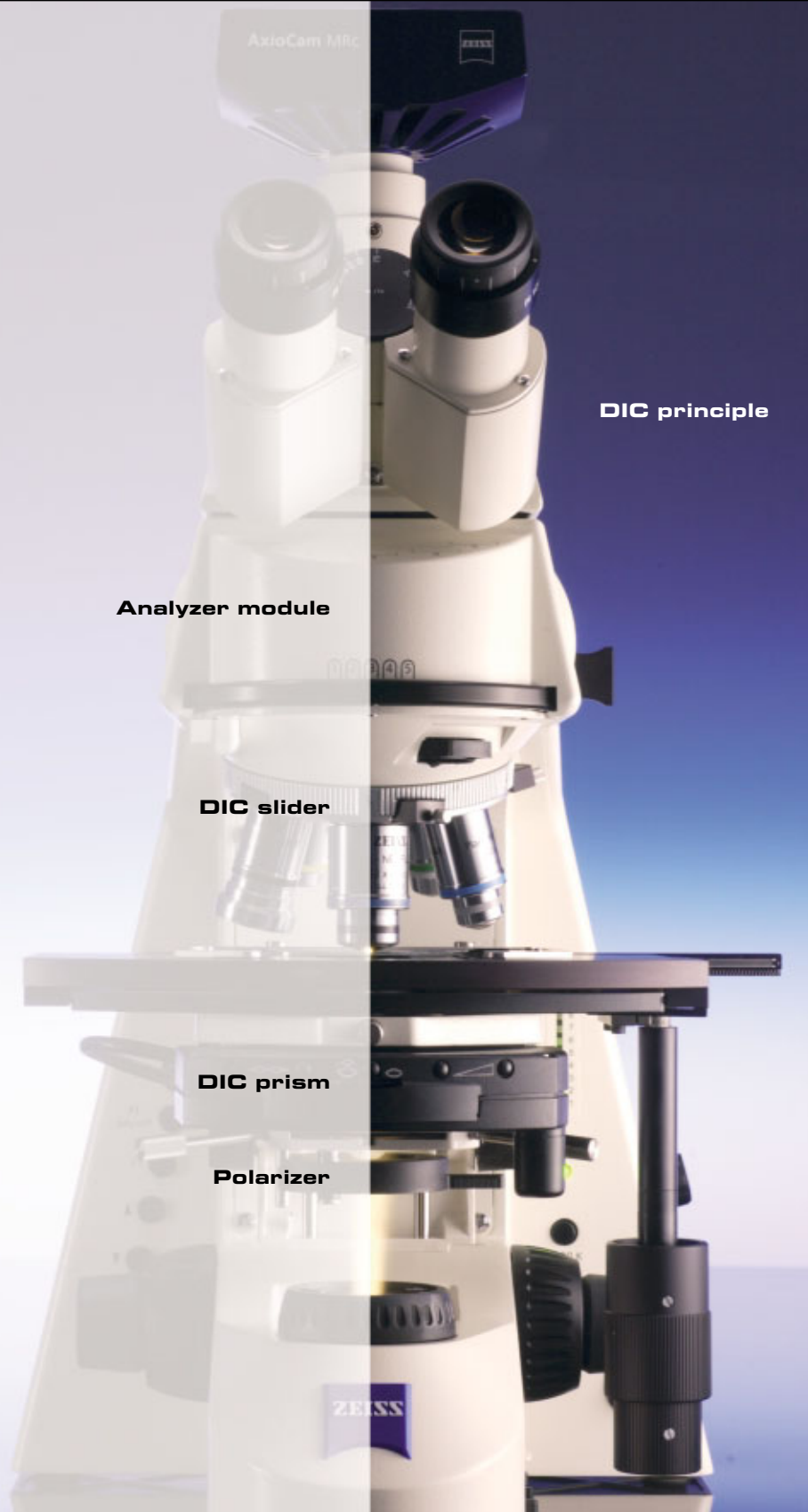

DIC principle

Differential Interference Contrast (DIC)

Nomarski interference contrast is ideal for thick, unstained specimens. This technique provides optical sections with optimum resolution, thus permitting the clear identification of fine structures in defined focal planes.

The contrast is set via objective-specific DIC sliders in the nosepiece, so the contrast is always maintained once it has been set.

The DIC prisms in the condenser are available with integrated polarizer. When reflector turret and condenser are motorized, a single push of the button is sufficient to change from epi-fluorescence to transmitted light DIC.

*Cell culture,
DIC*

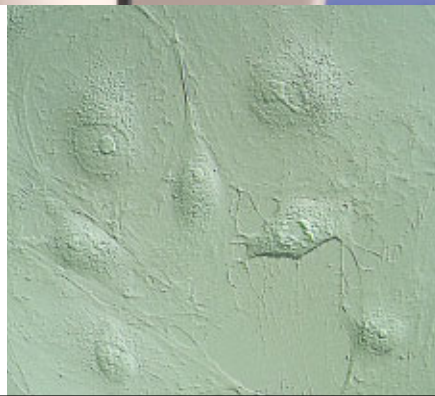

Illumination and Contrasting in Transmitted Light

The transmission parameters of the transmitted light beam path permit all contrasting techniques in the visible light range. The light intensity can be set either via modification of the lamp voltage or by maintaining the color temperature with neutral-density filters. The switchable filter mount also accepts color filters as required.



The condenser system

The condenser plays a major part in the setting of the various contrasting techniques and – when properly adjusted – ensures efficient and homogenous specimen illumination. All condenser systems can be set for Köhler illumination.



**Beam path
Transmitted Light**

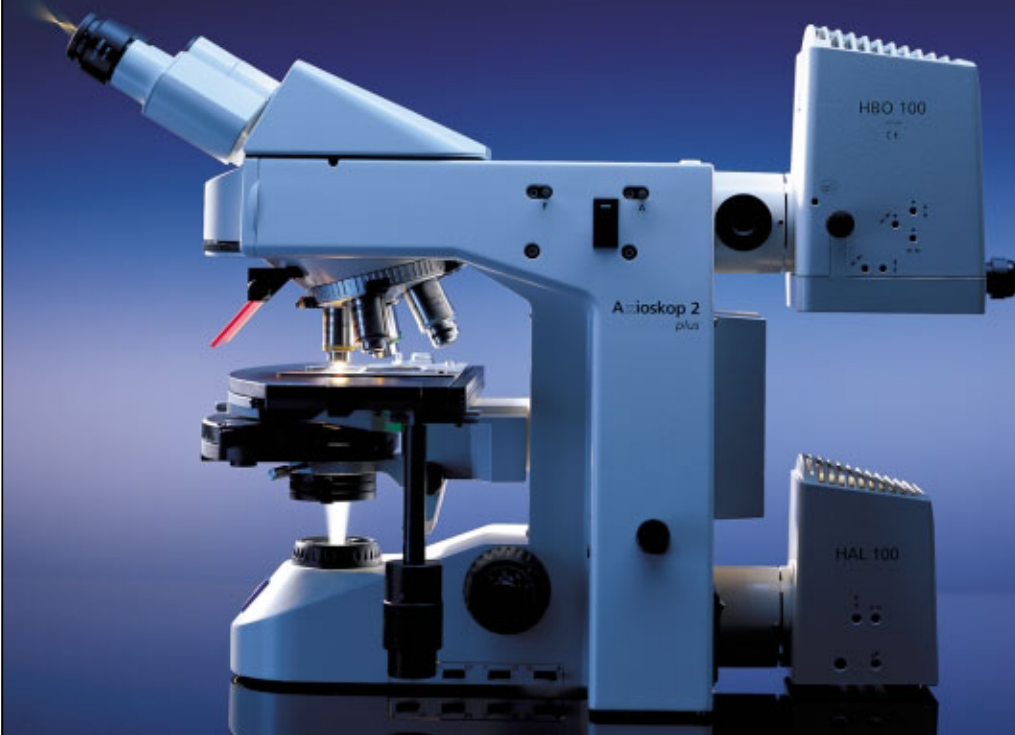

Light source

The easily adjustable standard 100 Watt halogen light source provides sufficient light intensity for all the traditional transmitted light contrasting techniques.

Condensers for every technique

The achromatic-aplanatic universal condenser with aperture 0.9 is suitable for almost all applications. Whether manual or motorized, it covers the entire magnification range from 1x to 100x. Its seven positions provide ample space for all the contrasting components of traditional microscopy: phase stops 1 to 3, DIC prisms I to III with or without polarizer, darkfield stop and polarizer for transmitted-light polarization microscopy.

All motorized condenser functions can be triggered at the push of a button or via the AxioVision application software.

The achromatic switching condenser with aperture 0.9 is suitable for less complex brightfield and phase contrast applications.

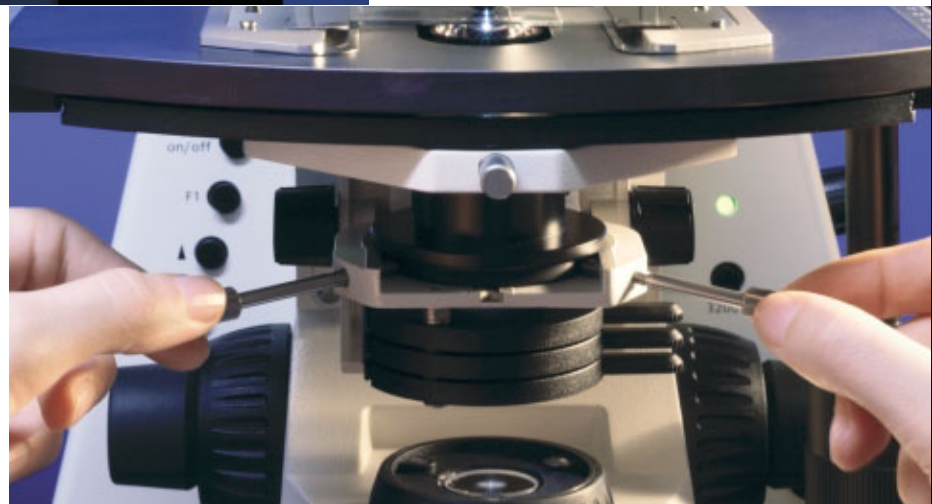

Oil immersion objectives and condensers with oil immersion optics permit optimum resolution of the microscope image. The achromatic-aplanatic condenser with aperture 1.4 has been optically corrected for this purpose.

Whenever specimen vessels require long working distances, the achro-

matic condenser 0.8 with 7 mm working distance is used for bright-field, phase contrast and DIC applications.

Complex darkfield with special dark-field condensers: oil immersion with the ultra condenser 1.2/1.4, dry applications with the dry darkfield condenser 0.8/0.95.

Epi-Fluorescence Microscopy

Fluorochromes and special labeling techniques are being used more frequently where the accurate reproduction of defined cell and tissue structures is required. Today, epi-fluorescence is the standard fluorescence technique. It is particularly efficient and permits a compact design of the filter modules. Furthermore, epi-fluorescence images and those provided by the transmitted light technique can be combined in a single image.

Today, traditional fluorescence dyes such as DAPI, FITC, Rhodamine and Texas Red are increasingly being replaced by even more efficient fluorochromes, e.g. Alexa Fluor™ and Cyanin.

Examinations of living specimens in transmitted light are supplemented and extended with fluorescent proteins (CFP, GFP, etc.). Experiments previously only possible in-vitro can now be performed directly in the living cell.

The Antiflex epi-polarization system visualizes the adhesion structures of cells on glass substrates. Together with fluorescence techniques, this permits the analysis of the function and structure of cytoskeletal elements.

*Hep-2 epithelial cells,
immunofluorescence
of Cyclin I in cell nuclei
(FITC)*

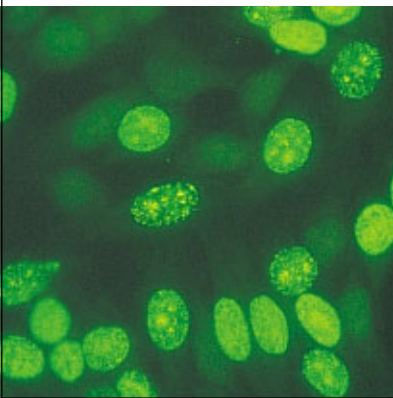

*Hep-2 epithelial cells,
immunofluorescence
of mitochondria
(FITC)*

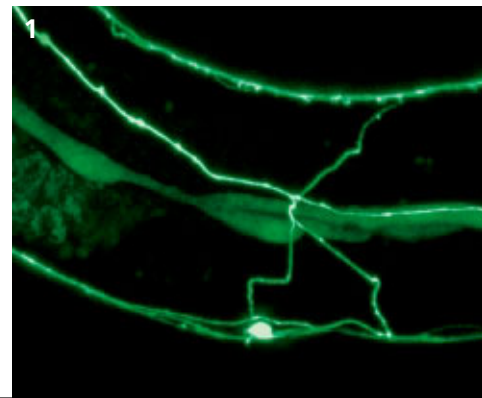
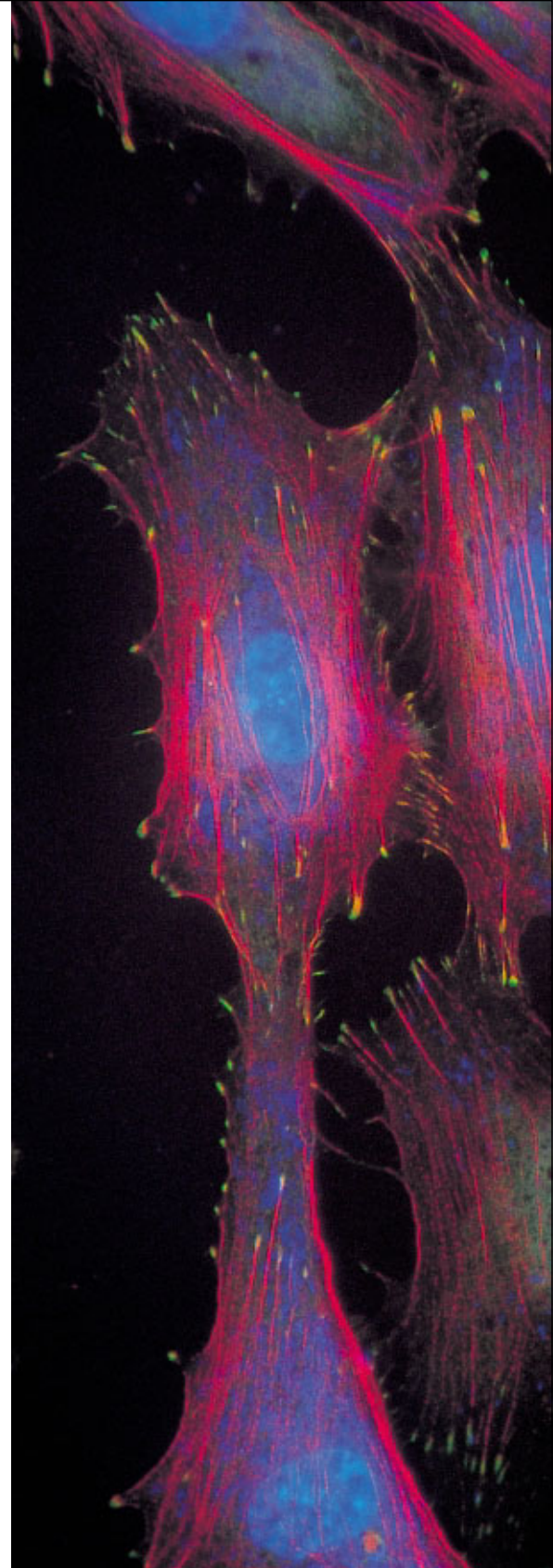
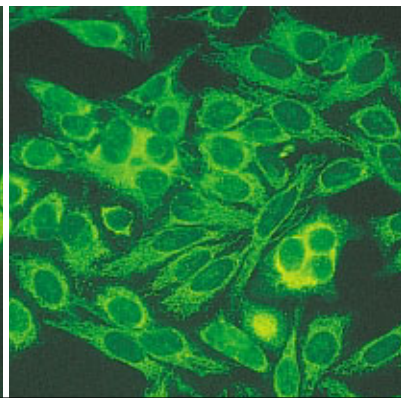

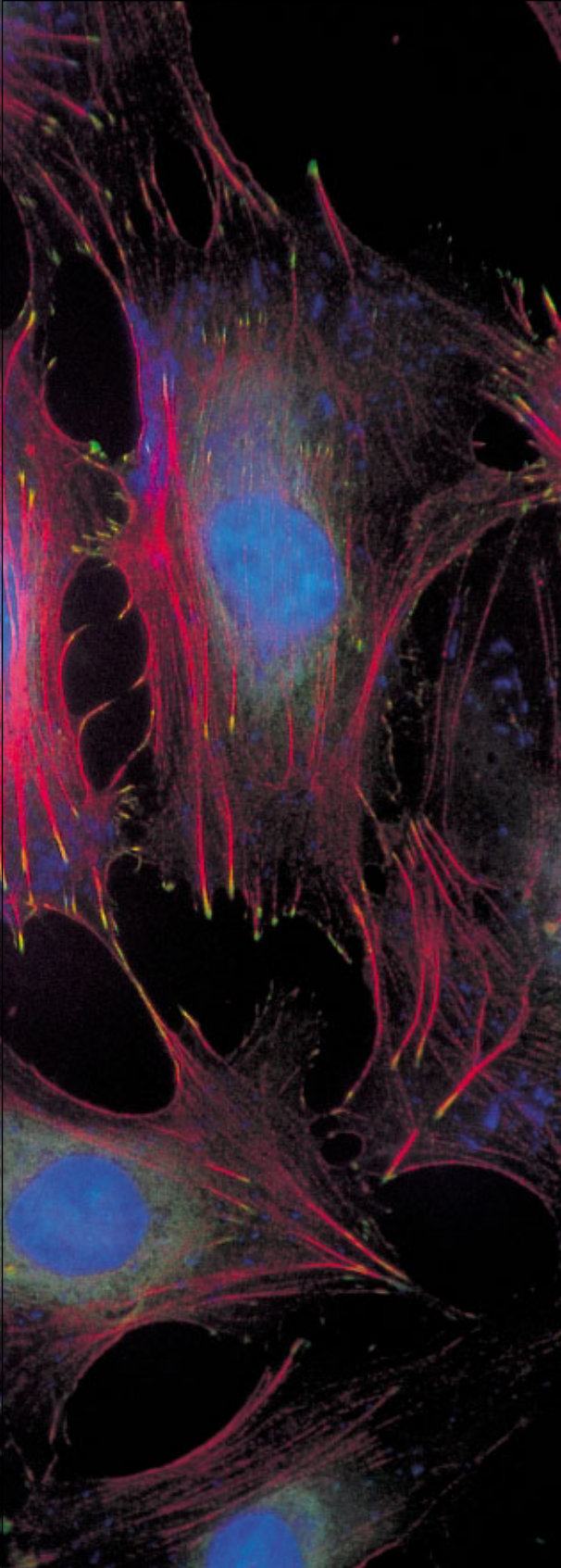

Human endothelial cells,
quadruple fluorescence
DAPI, Alexa 350, Alexa 488,
Phalloidin-Alexa 594.
J. Zbaeren, Inselspital,
Bern/Switzerland

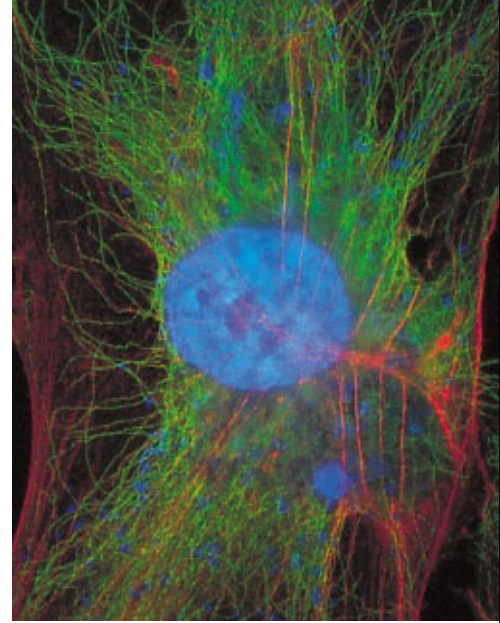

Human endothelial cells,
quadruple fluorescence
DAPI, Alexa 350, Alexa 488,
Phalloidin-TRITC.
J. Zbaeren, Inselspital,
Bern/Switzerland

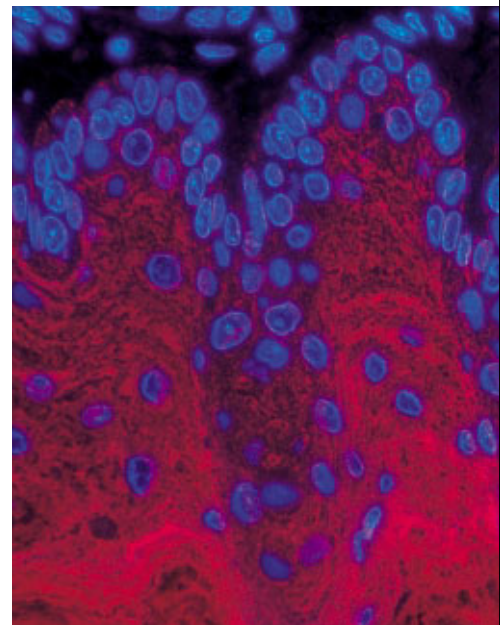

Tongue, rat,
double fluorescence
Alexa 594, DAPI.
J. Zbaeren, Inselspital,
Bern/Switzerland

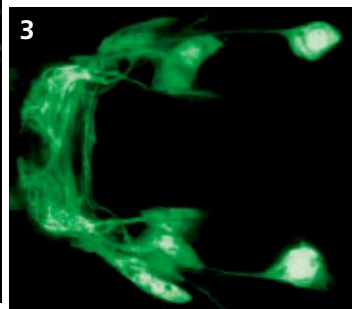

1-3
C. elegans,
GFP-marked neurons.
H. Hutter,
MPI Heidelberg/Germany

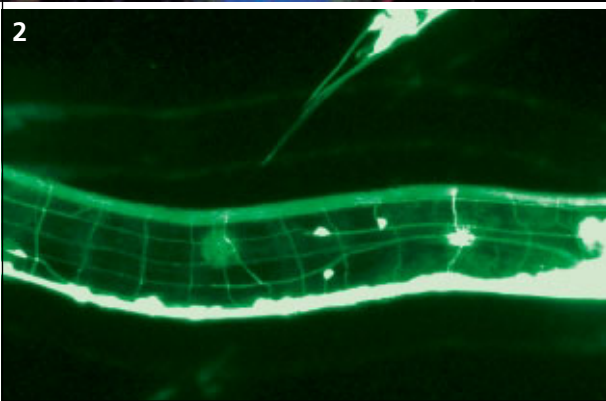

Illumination and Contrast in Fluorescence

The beam path required for epifluorescence can be integrated – and retrofitted – into the **Axioskop 2 plus** and **Axioskop 2 mot plus** microscopes. The viewing height remains unchanged, since the stand has been prepared for this integration.

Fluorescence configurations

The beam path is equipped with an adjustable and centerable luminous-field diaphragm and aperture stop. The adjusting aid is available for easy adjustment of the illumination source after a lamp change.

Reflector turret

The 5-position reflector turret is always included in the basic stand. Manual, coded and motorized versions are available. It permits easy switching between transmitted and reflected light techniques with very convenient push-button operation in the motorized version.

P&C modules

The filters required for fluorescence microscopy are integrated into the Push&Click modules which can be attached to the reflector turret and removed from it without any tools. Therefore, many different fluorochromes can be examined quickly and efficiently. The patented Light Trap principle provides optimum fluorescence signals without any disturbing background noise.

External filter wheel

A further increase in flexibility of fluorescence microscopy is provided by the motorized 8-position filter wheel (option) for the **Axioskop 2 mot plus**. Multiple fluorescence applications are easy to perform.

Adjusting aid



Filter wheel



Change of filter cubes – the Push&Click technique

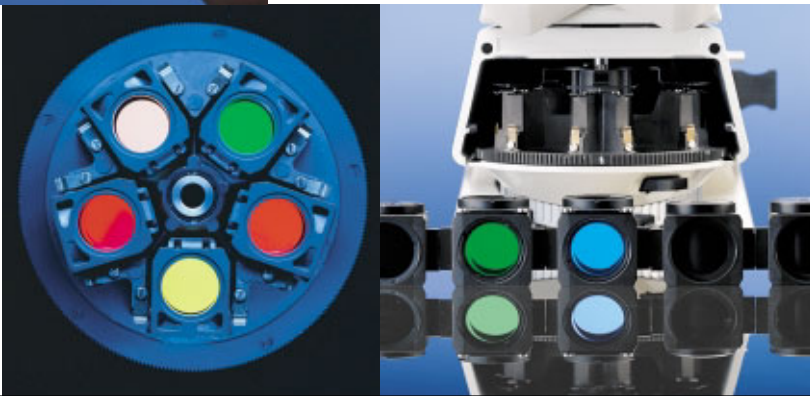

The 5-position reflector turret for Push&Click filter cubes

Beam path Fluorescence

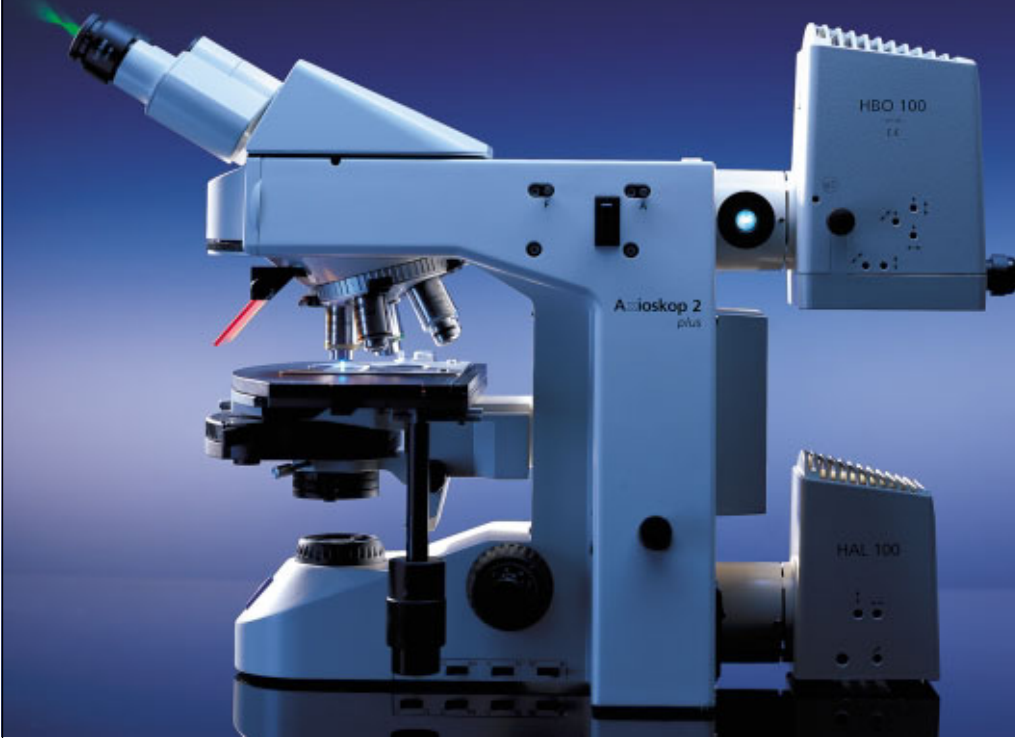

Light source

The high-energy HBO 103 mercury vapor short-arc lamp is used for almost all fluorescence techniques. Clearly allocated and easy-to-operate setting screws in the lamp housing permit fast and precise lamp adjustment which can be monitored through the window of the adjusting aid. The lamp is inserted into the pre-centered clamping device without any need for a special tool.

Light trap

Stray radiation passes through a beam splitter (2), leaves the filter cube (1) directly through the rear opening (3) and is then directed out of the beam path through the conical mount (4) of the filter turret (5). The results are self-explanatory: considerable contrast enhancement, increased image definition and brilliance, higher sensitivity due to an improved signal-to-noise ratio.

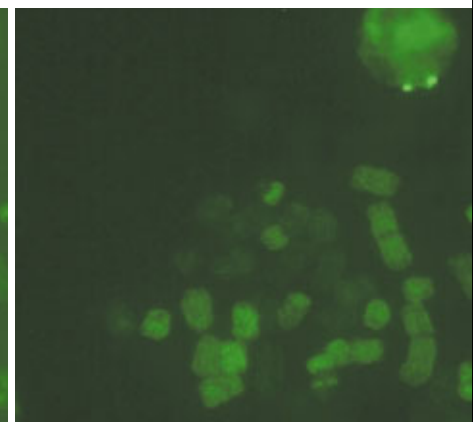
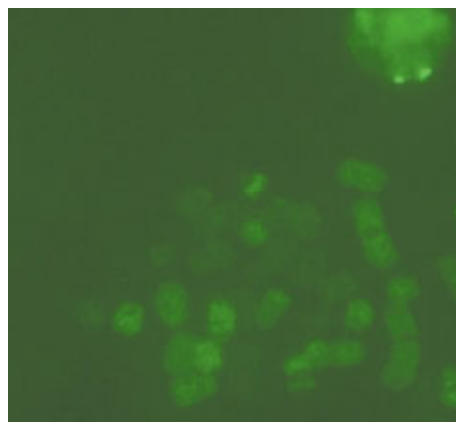

Beam path in a traditional reflector module

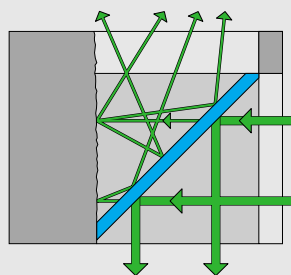

Beam path with light trap

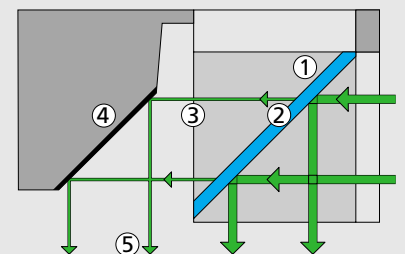

Objectives for Observation and Measurement

Infinity optics were designed and computed by August Köhler as far back as the thirties. But it was not before the invention of ICS (Infinity Color-corrected System) in 1986 that this optical system became the centerpiece of modern Light Microscopy.

Simply said, the function of the ICS optics is to achieve optimum performance by using the minimum number of optical elements. Since every optical element contributes to the reduction of light transmission, the minimization of optical components means the maximization of the overall optical performance.

All in all, this resulted in visible improvements of image contrast, brightness and detail resolution.

A-Plan objectives



Achroplan objectives



Plan-Neofluar objectives



Fluar objectives



Plan-Apochromat objectives



An attractive alternative

Are you looking for a budget-priced alternative to Achromplan objectives? Here it is: A-Plan objectives are reliable in daily routine, clinical diagnostics and research. They provide rich contrast, are suitable for fluorescence and can be used with eyepieces with a field of view of up to 23 mm. They are applicable for brightfield and phase contrast techniques.

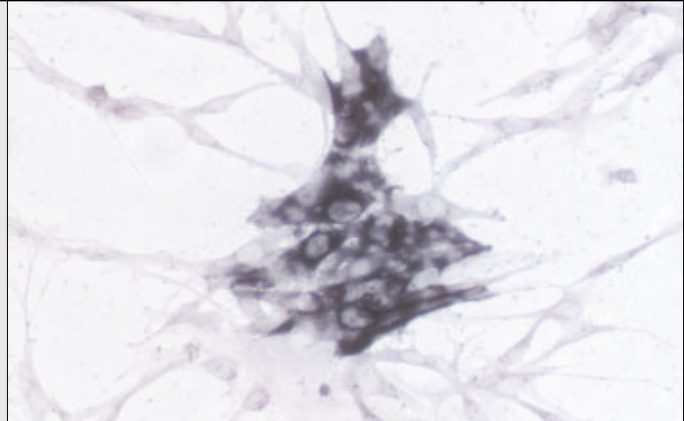

A sound basis

These are the basic objectives for your daily transmitted light routine and for epi-fluorescence microscopy with visible-light excitation. Thanks to their high image flatness across field diameters of 23 mm, Achromplan objectives are ideal for image documentation (photomicrography and digital microscopy).

LD-Achromplan objectives are also available for extremely long working distances with high apertures. Special Achromplan water objectives are provided for applications in physiology.

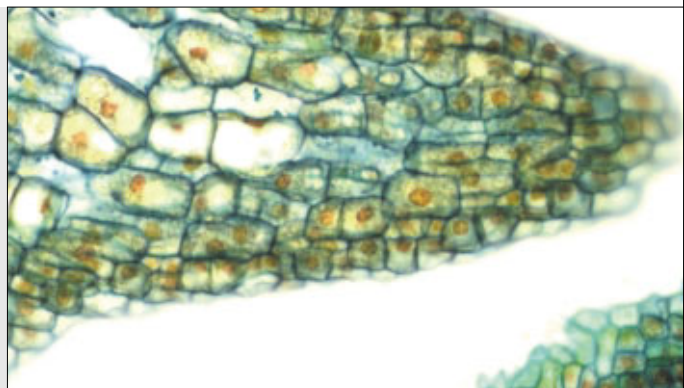

The allrounders

Where flexibility and a wide range of techniques are prime concerns, the universal semi-apochromatic Plan-Neofluar objectives are the best answer. With a transmission range up to the near UV, achromatic correction, optimum working distances, low strain and high numerical apertures, they are ideal for brightfield, darkfield, phase contrast, DIC, polarization and fluorescence. High contrast and clear definition make them the right choice for image processing and analysis.

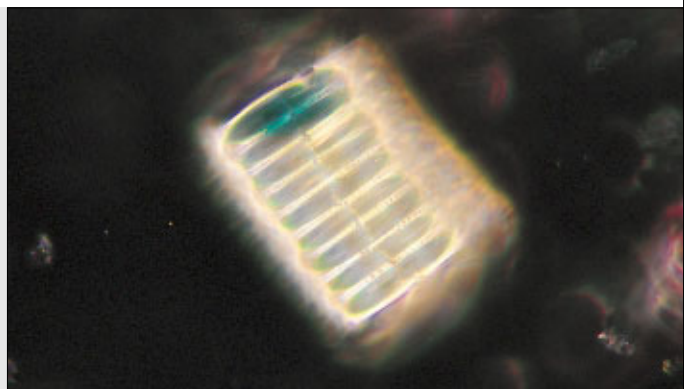

The photon gatherers

The Fluor line is designed for maximum transmission and photon gathering efficiency. Made of special optical glass types, these objectives feature high numerical apertures, high contrast and high transmission for the entire visible spectrum up to the near UV. If you want to detect the faintest fluorescence, Fluor objectives from Carl Zeiss are your best choice.

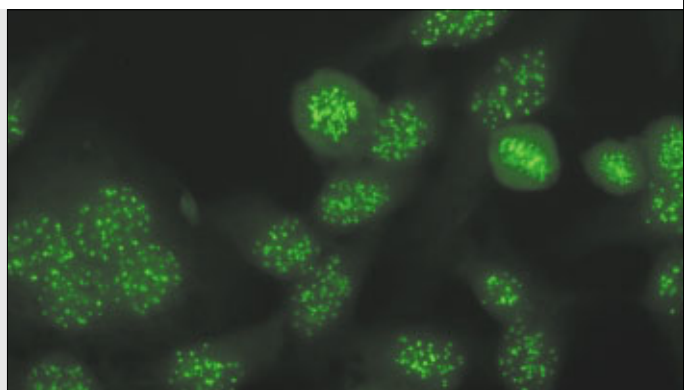

The ultimate imaging experts

Combining the highest color correction with highest numerical apertures, Plan-Apochromat objectives deliver the ultimate in resolution and image definition and thus provide the finest details and subtlest color nuances. The large apertures enable brilliant brightfield and DIC images – and ensure high performance in fluorescence.

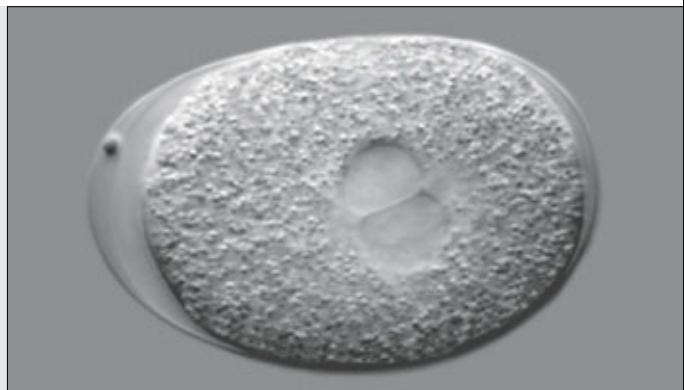

Microscope Stages to Move the Specimen

Three stage models are available for the precise movement of the specimens in the x-y direction: manual, coded and completely motorized. They are attached to the stage and condenser carriers of the **Axioskop 2 plus** and **Axioskop 2 mot plus** microscopes without any need for special tools.

Manual version

Mechanical stages, manually moved in x and y, with a travel range of 75x50 mm, are the most traditional types of microscope stages. Depending on requirements, they are available with coaxial x-y drive on the right or left. The centerable rotary mechanical stage 75x50/240°R with x-y drive on the right provides a rotation range of 240°. The controls can be positioned at any height required and their smoothness set as required by the user.

Coded and manual version

An electrical vernier scale permits the reading of x-y data of the mechanical stage 75x50R. The x-y positions can be displayed either directly or transferred to an application software.

The mechanical stage 75x50 mot features its own control unit. The specimen can be moved optionally via a 2-axis joystick or a coaxial electrical drive.

Fully motorized control

The scanning stage DC 4" x 4" has been designed for entirely motorized experiments. The connection to the control computer is made via a motor control unit. However, the x-y movements of the stage can also be performed via an optional control panel for two axes.

*Vertically adjustable
control elements on the stage drive*

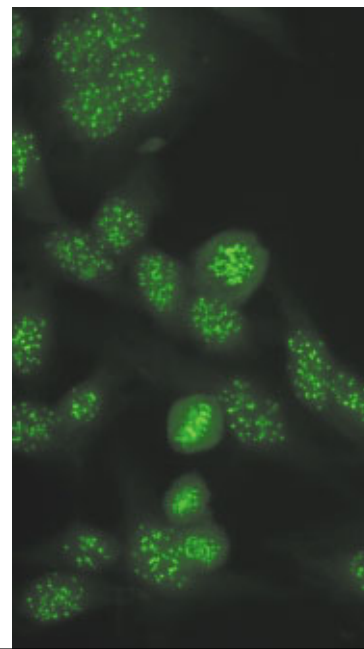

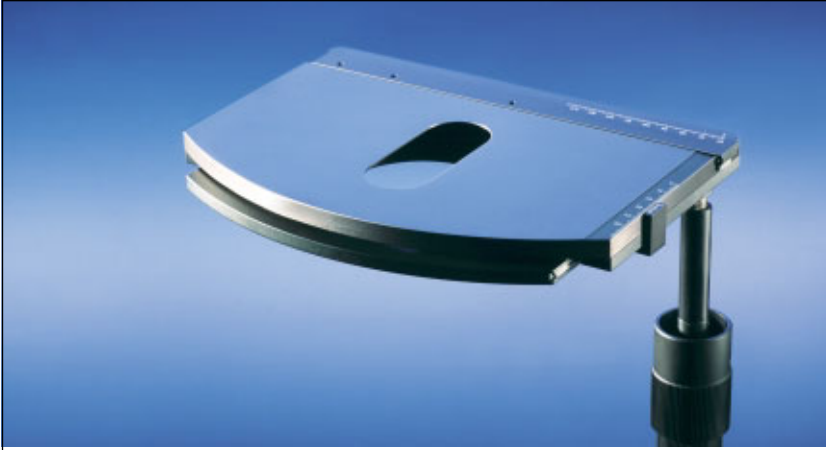

Mechanical stage with stage drive on the right



Mechanical stage with stage drive on the left

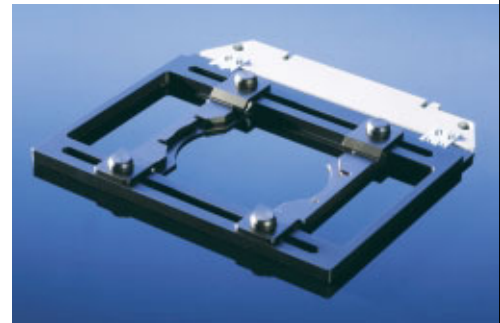

Specimen holders

A wide variety of specimen holders is available for microscopy. From the simple model for manual mechanical stages to universal heating frames for complex experiments and various inserts for fully motorized microscope stages.



Motorized mechanical stage

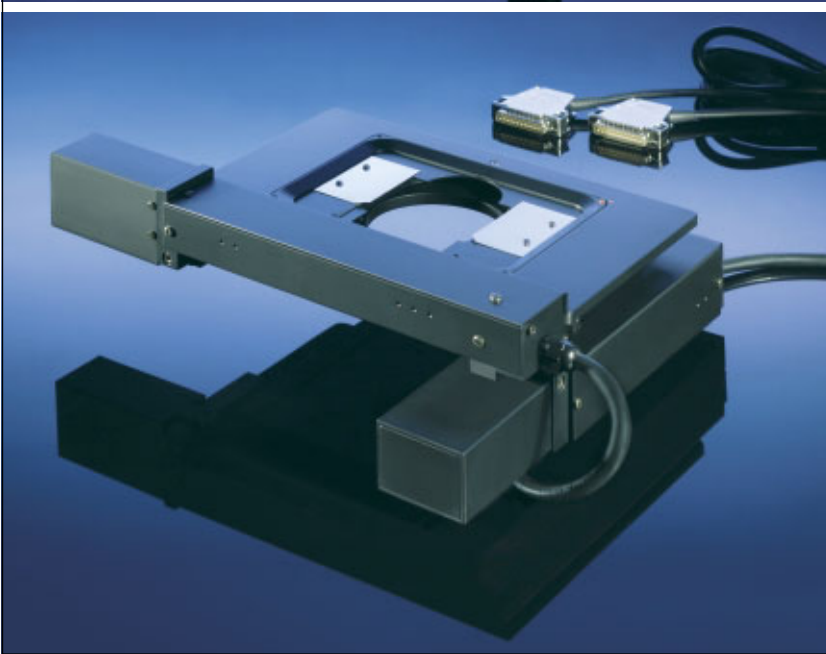

DC scanning stage

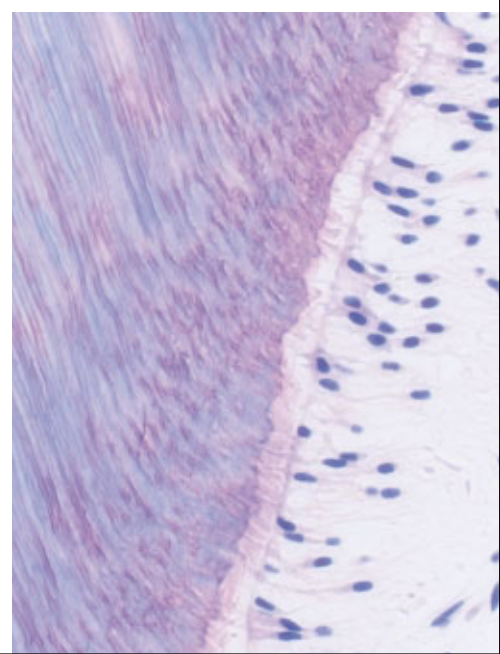

A Single System for Documentation and Evaluation

Image documentation and analysis are a must in daily routine and research. No matter whether you use an SLR, video or digital camera, the binocular phototubes permit easy recording and display of the specimens.

Digital photography

Traditional, time-consuming photography is being replaced more and more by cameras with light-sensitive sensors. The image of the specimen is readily available on the monitor and can be processed immediately. Documentation is further facilitated by the modern, digital AxioCam microscope camera, featuring easy operation and optimum resolution.

Digital image documentation

Documentation is supported by the application-specific AxioVision software. Image recording, simple image processing, annotations and image archiving can be performed in no time at all. The hand-written, time-consuming recording of test procedures is a thing of the past. And if required, the results can be printed quickly on customized report forms.

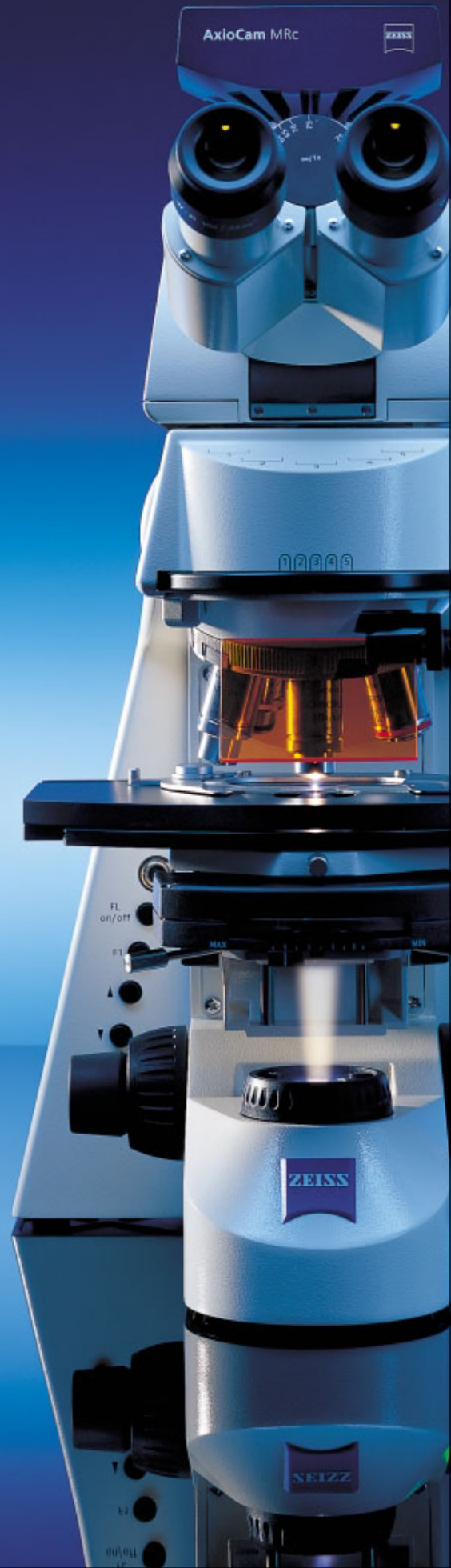

Amo International Inc. 
 Central Quality Control Laboratory
 OC - Image Archive

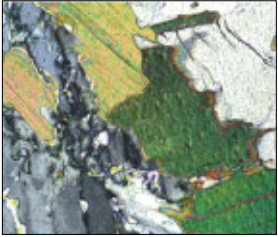

Keywords: Pol color etched

Comments: Material is color-etched FeC/Ni
 Delivered to MNO Ltd.
 Delivery Date: Aug. 31, 1998
 State: Final approval required

 MNO Institut

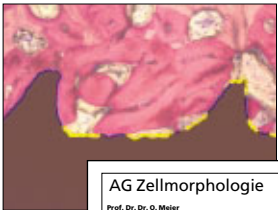

Keywords: Zahnlänge

ZL GmbH 

Musterstraße 4
 D-55051 Mainz
 Telefon: +49 (93) 95 97-0
 Fax: +49 (93) 9597-100

Bild: Osteo0312
 Datum: 27.07.98
 Kommentar: Knochenquerschnitt mit Goldner-Färbung (rot: Osteoid, grün: Trabekel), Wachstumsaktivität
 Bildaufnahme mit AxioCam, Durchlicht, PlanNeofluar 20 x, SONY 550 3-CCD RGB Kamera.

Stichwort: Osteoid Trabekel

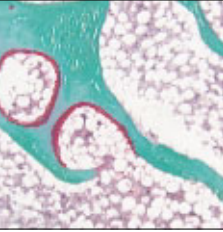

AG Zellmorphologie 

Prof. Dr. Dr. O. Meier
 Gebiäude 105 r15
 D-10000 Münsterstadt
 Telefon: +49 (93) 9597-0

Titel: Fluor0020
 Datum: 22.05.98
 Autor: Dr. Dr. Müller
 Kommentar: Mehrfach-Fluoreszenz:
 DAPI
 FITC
 Texas Red

Stichwort: Fluorescence Multichannel

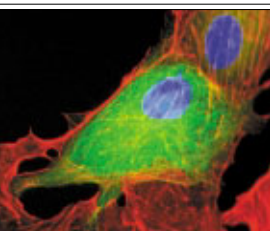



AxioVision, Ideal for Documentation

Together with the AxioCam digital camera, the AxioVision application software and its additional modules are ideal for all image-related documentation tasks using the **Axioskop 2 plus** and **Axioskop 2 mot plus** microscopes. Image acquisition, processing and archiving are time-saving and low-cost procedures.

All the motorized microscope components are integrated into the application workflow and can be controlled via the software. All the required documentation parameters such as magnification factor, contrasting technique, exposure times, etc., are ready and available at the push of a button. Time-consuming test records are a thing of the past.

Triple fluorescence

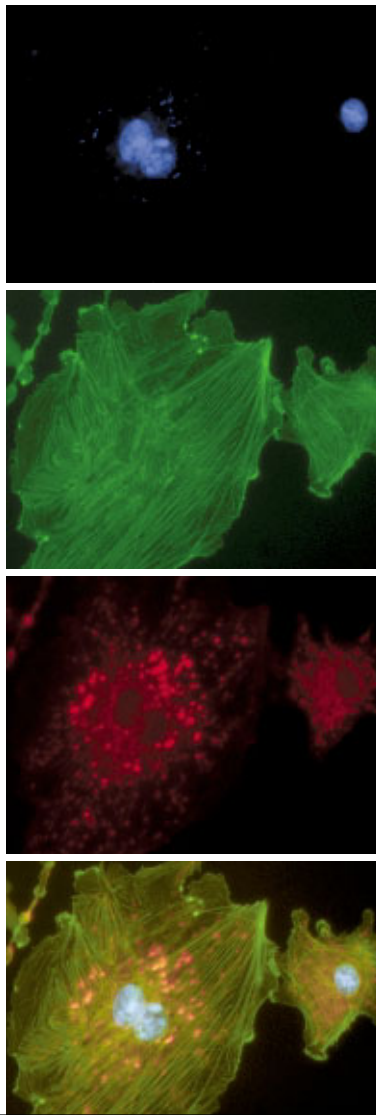

Easy insertion of text and graphics elements

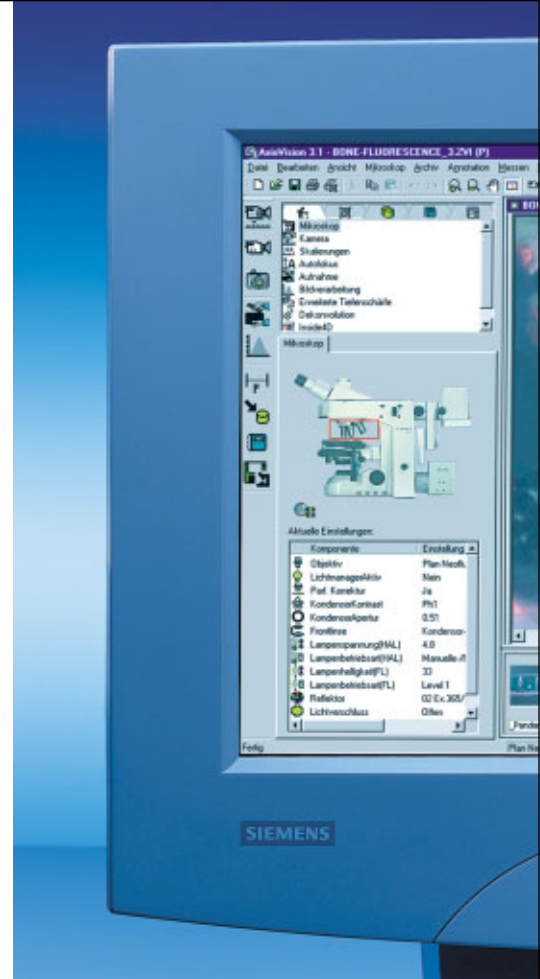
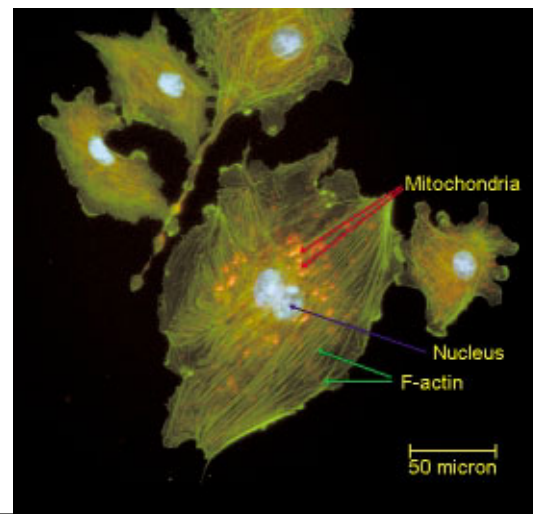

Digital Photography

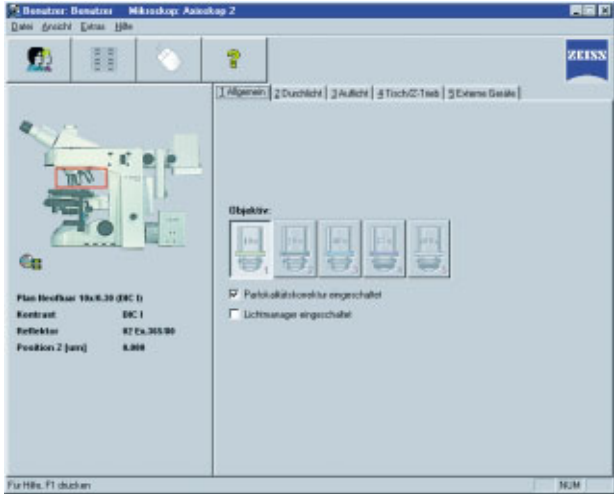
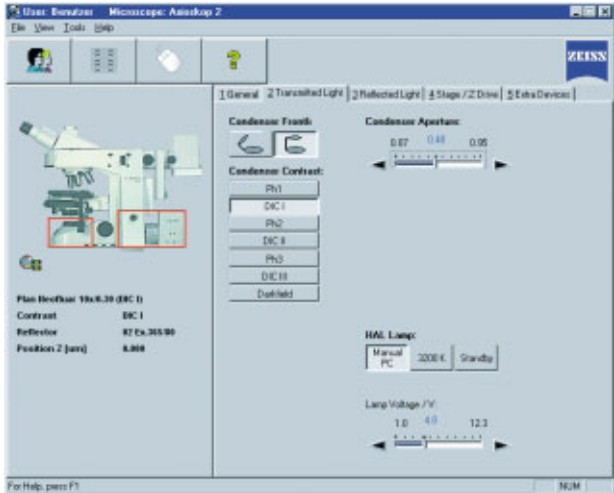

AxioVision system package

Even the basic version of AxioVision permits complete control of all motorized microscope components, in addition to image documentation and archiving. Suitable software modules are available for complex applications such as multichannel fluorescence, time-lapse microscopy and z-stacks, or combinations of these applications.

This permits complex experiments to be easily configured and triggered at the push of a button.

All system parameters are recorded automatically and are available at all times for recurring experiments, thus ensuring the reproducibility of recording conditions.

Magnified section, cat cerebellum, silver staining. J. Zbaeren, Inselspital, Bern/Switzerland

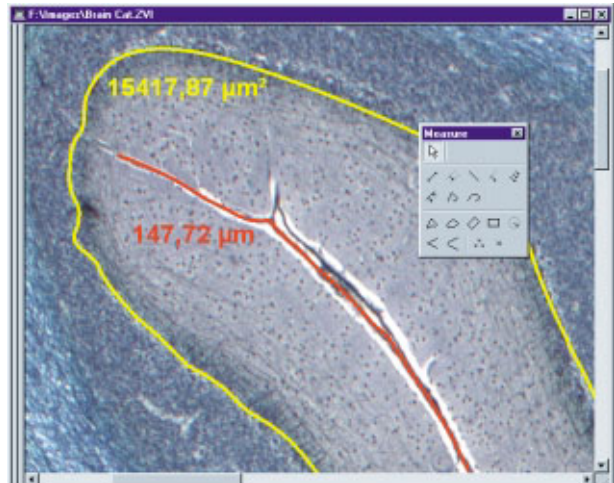

System overview

Axioskop 2 plus / Axioskop 2 mot plus

Specimen holder, special with particular fixation particularly for immersion objectives
000000-1070-589

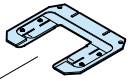

Heatable universal mounting frame A-H
000000-1116-055
Tempcontrol 37 analog (1-channel)
000000-1116-057

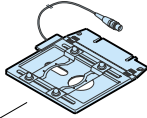

Universal mounting frame for Petri dishes and specimen slider
000000-1100-843

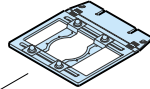

Specimen holder for mechanical stage 75x50
000000-1067-330



Mechanical stage 75x50 R
(with electronic vernier scales)
000000-1046-520
(with display unit SCD
413507-9001-000)

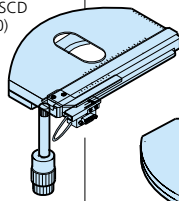

Mechanical stage 75x50/240° R
000000-1067-325

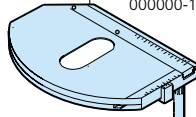

Mounting frame for heating and cooling devices
000000-1107-544

Mechanical stage 75x50 R
000000-1063-835

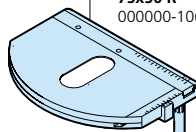

Mechanical stage 75x50 L
000000-1063-836

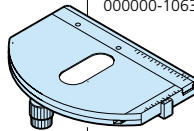

Mechanical stage 75x50 mot with display unit
000000-1025-145

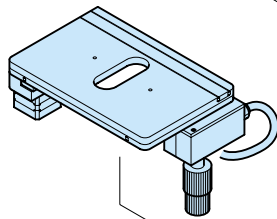

Specimen holder
473448-0000-000
453538-0000-000
453545-0000-000
(according price list)

optional

Joystick for 2 axis
000000-1033-996
or
Coaxial electr. drive
000000-1034-960

Scanning stage DC 4"x4"
000000-1027-823)
(displacement range
max. 65x50 mm with
motorized condensors)

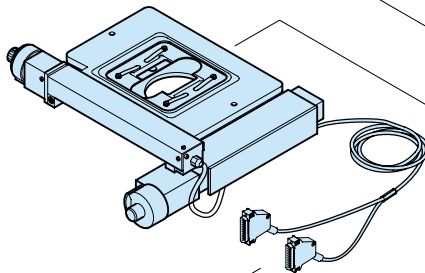

optional
Control panel for 2 axis
457433-0000-000
(for manual operation)

DC motor control 3 axes, MCU 28
457428-0000-000

for MOT-stand
CAN-Bus-cable 2.5 m
457411-9011-000

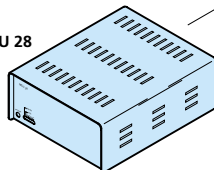

Eyepiece eyecup
444801-0000-000



Eyepiece W-PI 10x/23 Br.
000000-1016-758
Eyepiece PI 16x/16 Br.
444053-0000-000



Eyepiece PI 10x/23 Br. foc.
000000-1026-548
Eyepiece PI 16x/16 Br. foc.
444054-0000-000

Format reticule MC 2.5x/d=26 mm
454075-0000-000
Format reticule MC 3.2x/d=26 mm
454076-0000-000
(additional format reticules
according price list)

Eyepiece W-PI 10x/23 Br.
455043-0000-000
(only in combination with the tubes
452340-0000-000 and 452344-0000-000)
(optional: diaphragm, screwable
455043-0206-000)



Auxillary microscope d=30
000000-1006-362

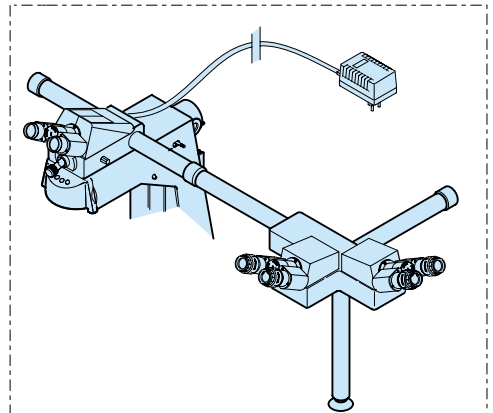

Multi-observation equipment for Axioskop 2

Intermediate tube with light pointer and power unit
452380-0000-000
Tube carrier R (connection) for multi-observation equipment
452381-0000-000
Tube carrier L (connection) for multi-observation equipment
452382-0000-000
Tube carrier R (panael) for multi-observation equipment
452383-0000-000
Tube carrier R (panael) for multi-observation equipment
452384-0000-000
Binocular tube 30°/20 for multi-observation
452927-0000-000
Eyepiece E-PI 10x/20 Br. foc.
444232-9902-000

Stage carrier with condenser carrier
452327-0000-000
or
Condenser carrier for FS
000000-1022-999

Axioskop 2 FS plus microscope stand
000000-1066-600
Axioskop 2 FS MOT microscope stand
000000-1066-601

Filter set VIS/IR
000000-1031-489

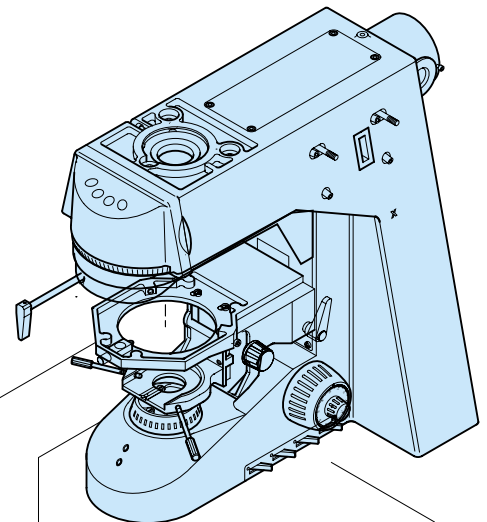

Video adapter C-mount

- Video adapter 60 C 1/3" 0.4x**
456108-0000-000
- Video adapter 60 C 1/2" 0.5x**
456106-0000-000
(000000-1069-415 in preparation)
- Video adapter 60 C 2/3" 0.63x**
000000-1069-414
- Video adapter 60 C 2/3" 1.0x**
456105-0000-000

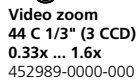

Video zoom 44 C 1/3" (3 CCD) 0.33x ... 1.6x
452989-0000-000



Video zoom 44 ENG 1/2" 0.5x ... 2.4x
452984-0000-000

Video adapter ENG-mount



Video adapter 44 ENG 1/2" 0.63x
452992-0000-000



Video adapter 60 ENG 2/3" 1.0x
456115-0000-000

Adapter from 60 to 44
456140-0000-000



Video camera
as desired

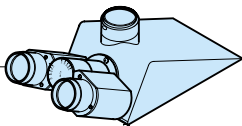

Binocular phototube 30°/23 (70:30)
452344-0000-000

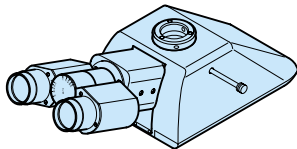

Binocular ergonomy phototube 6-25°/23 (100:100)
452342-0000-000

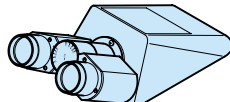

Binocular tube 30°/23
452340-0000-000

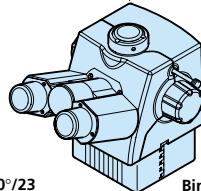

Binocular ergonomy phototube 20°/23, height adjustable
000000-1104-296

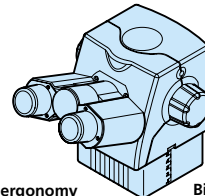

Binocular ergonomy tube 20°/23, height adjustable
000000-1104-293

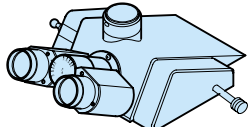

Binocular phototube with sliding prism 30°/25 (100:0/50:50/0:100)
452143-0000-000

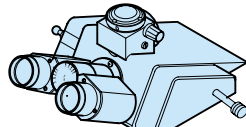

Binocular phototube with two TV ports 30°/25 (100:0/50:50/0:100)
452145-0000-000

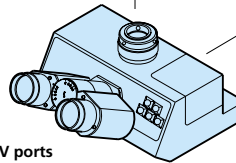

Double video adapter
000000-1058-640

Double TV-tube mot. with 2 outputs
000000-1054-146
Accessories
acc. price list

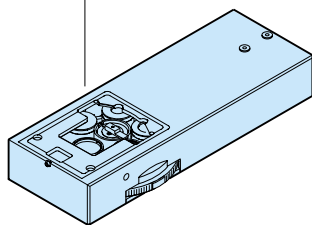

Optovar intermediate tube 1.0x/1.25x/1.6x/2.0x/2.5x cod.
452175-0000-000

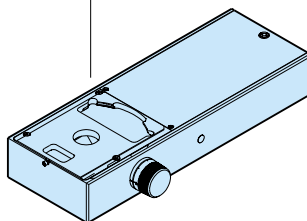

Intermediate zoom tube 1.0x ... 2.5x cod.
452180-0000-000

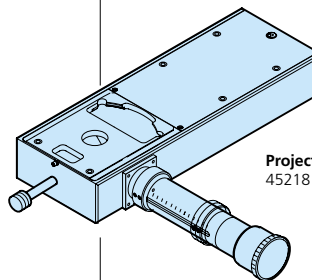

Projector tube for image interpolation
452181-0000-000

Adapter
452969-0000-000

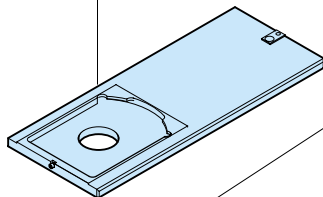

Polarizer D, fixed
453615-0000-000



Polarizer D, rotatable
453620-0000-000



Polarizer fixed with lambda plate, rotatable
445226-0000-000



Senarmont polarizer DIC
453622-0000-000



Color filter carrier 3x for filter d=32 mm
452159-0000-000
Polarizer with filter holder
000000-1118-003

Cable release
416167-0000-000

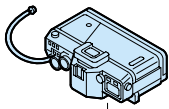

Single-lens reflex camera housing
CONTAX-ARIA
000000-1057-127



T2-adaptor for CONTAX
416010-0000-000
(additional T2-adaptor acc. price list)



Adapter T2 2.5x for SLR
456005-0000-000

**Camera adapter
D40 M52x0.75**
000000-1096-522



**Connector 60 for
microscope camera
d=30**
456006-0000-000

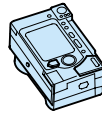

Compact digital camera,
e.g. **SONY DSC-575**
72 MB, d=52mm (D)
000000-0425-186



**Digital camera adapter
44 M52x0.75**
000000-1108-984



Attachment for 60-44
456140-0000-000

Microscope camera MC 80
See price list for equipment
and accessories

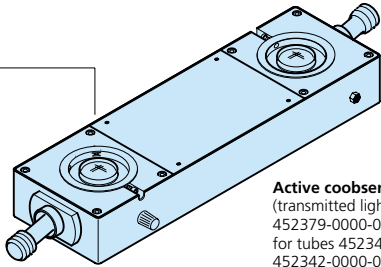

Active coobservation device for the Axioskop 2
(transmitted light) with light point and power unit
452379-0000-000
for tubes 452340-0000-000 (only rear);
452342-0000-000 (in front and rear)

Incident light equipment
000000-1150-310

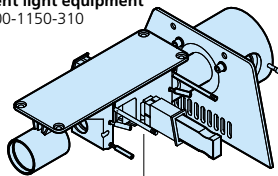

**8-position filter wheel for
dia. 25 mm excitation filters**
(only with MOT stand, PC and
microscope control software)
000000-1008-106

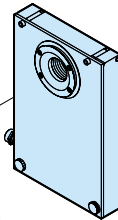

**Adjusting aid
for HBO/XBO**
452369-0000-000

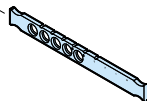

6-position FL filter slider
446377-0000-000

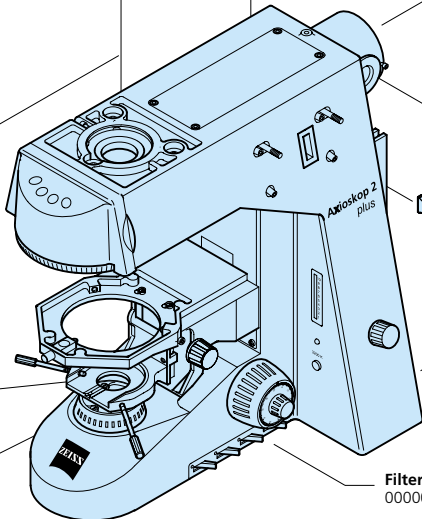

Filter set D
000000-1058-230

Axioskop 2 plus microscope stand
000000-1116-576
**6-position nosepiece H W 0.8
with 5-position reflector turret**
000000-1059-202
**5-position nosepiece H DIC W 0.8
with 5-position reflector turret**
000000-1056-430

Axioskop 2 mot plus microscope stand
000000-1130-660
**5-position nosepiece H DIC W 0.8 cod.
with coded, 5-position reflector turret**
000000-1058-255
**6-position nosepiece H W 0.8 cod.
with coded, 5-position reflector turret**
000000-1059-203
**5-position nosepiece H DIC W 0.8 cod.
with motorized, 5-position reflector turret**
000000-1144-840
Shutter for incident light equipment
000000-1144-850
(only in combination with
nosepiece 000000-1144-840)

Notebook
000000-1056-852/853
**Microscope control
software**
000000-1068-563

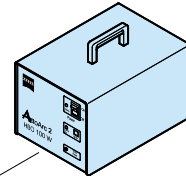

Variable intensity lamp control AttoArc 2 N HBO
adjustable 100-120-220-240 V 50/60 Hz
000000-1007-975

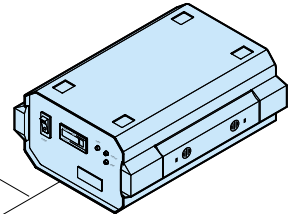

Transformer HBO 103 ebq 100 dc
000000-1003-928

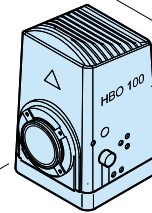

Lamp housing N HBO 103
000000-1007-980
Achromatic collector
000000-1007-978
Collector N HBO 103/XBO 75
000000-1007-976 or
Quartz collector N HBO 103/XBO 75
000000-1007-977
**Mercury vapor short-arc lamp
HBO 103 W/2**
380301-9350-000

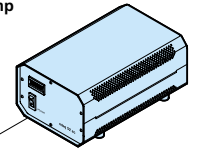

**Transformer mbq 52 ac-z
for HBO 50 220-240 V**
000000-1113-833

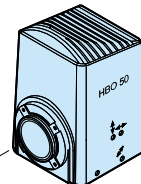

**Lamp housing HBO 50 incl.
lamp socket**
447220-0000-000
Kollektor HBO 50/SF 25
447270-0000-000
**Super-pressure mercury lamp
HBO 50**
381619-0000-000

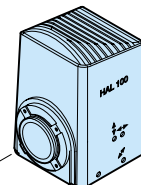

**100 HAL lamp housing with collector,
lamp mount**
447219-0000-000
Halogen lamp 12 V 100W
380079-9540-000

for external power supply HAL
absolutely essential for Axioskop 2 FS

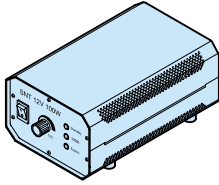

Power supply 12 V DC 100 W stabilized
000000-1128-574

Achr.-aplanatic universal condenser 0.9 H MOT
000000-1159-528
Achr.-aplanatic universal condenser 0.9 H D Ph MOT
000000-1159-529
Achr.-aplanatic universal condenser 0.9 H D Ph DIC MOT
000000-1159-531
Polarizer for condenser (000000-1159-531)
000000-1028-973

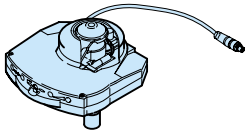

DIC prism I/0.9 (with polarizer)
000000-1005-002
DIC prism II/0.9 (with polarizer)
000000-1005-003
DIC prism III/0.9 (with polarizer)
000000-1005-004
DIC prism I/0.9
000000-1004-901
DIC prism II/0.9
000000-1004-902
DIC prism III/0.9
000000-1004-903

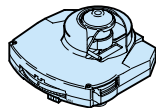

Achr.-aplanatic universal condenser 0.9 H
000000-1159-526
Achr.-aplanatic universal condenser 0.9 H D Ph
000000-1159-527
Achr.-aplanatic universal condenser 0.9 H D Ph DIC
000000-1159-530
Polarizer for condenser (000000-1159-530)
000000-1028-973

Achromatic switching condenser 0.9 H
000000-1017-688
Achromatic switching condenser 0.9 H D Ph
000000-1017-690

DIC prism II/1.4
445375-0000-000
DIC prism III/1.4
445376-0000-000

Achr. aplanatic condenser
1.4 H Ph DIC d=0,5 mm
445453-0000-000

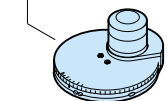

Achr. condenser 0.8 H
d=6.7 mm
000000-1087-444
DIC prism III /0.8
000000-1087-445



DIC prism III/0.8
445485-0000-000

Achr. condenser 0.8 H D Ph DIC
d=6.7 mm
445445-9901-000

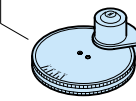

Ultra condenser
1.2/1.4(0.75-1.0)
465500-0000-000

Dry darkfield condenser
0.8/0.95(0.6-0.75)
465505-0000-000



Darkfield illuminator
445314-9901-000

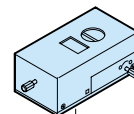

Condenser holder Z
for darkfield condenser
445323-0000-000



Analyzer module for
transmitted light
000000-1050-958
Optovar module 1.25x
000000-1046-284
Optovar module 1.6x
000000-1046-283
Optovar module 2.5x
000000-1046-282
Reflector module FL
000000-1046-281
Reflector module H
000000-1046-274
Filter sets
according price list

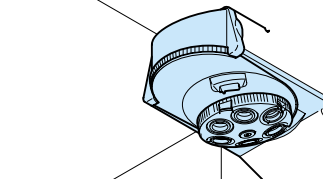

Analyzer DIC/FL
452374-0000-000
(additional to barrier filter on FL
or optovar module)



Compensator lambda, 6x20
473704-0000-000
Compensator lambda/4, 6x20
473714-0000-000
Compensator lambda,
rotary, +/-8° 6x20
473710-0000-000
Wedge compensator
0-4 lambda, 6x20
000000-1140-663

DIC slider
according price list



Antiglare screen
452163-0000-000

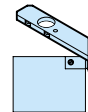

Adapter ring
W 0.8 without NG
000000-1104-291



Adapter ring W 0.8 NG 0.25
000000-1104-289
Adapter ring W 0.8 NG 0.10
000000-1104-290



Specimen marker
000000-1105-072
Refill set for
specimen marker
000000-0428-327



Objectives
(ICS objectives
according to price list)



Axioskop 2 plus

Axioskop 2 mot plus

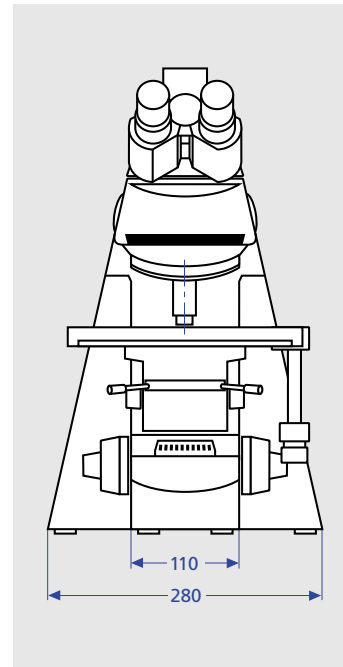
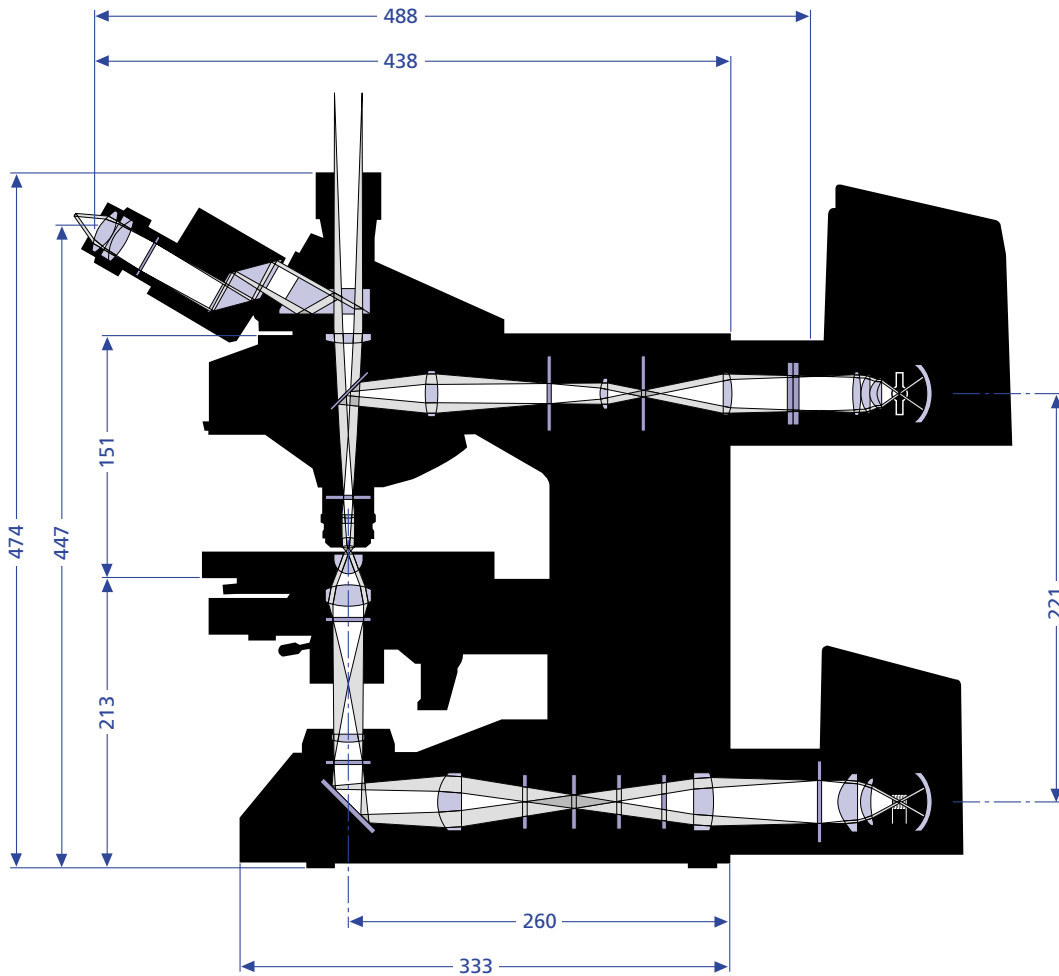

For further details, please contact:

Carl Zeiss Light Microscopy

P.O.B. 40 41
37030 Göttingen
GERMANY
Phone: ++49 5 51 50 60 660
Telefax: ++49 5 51 50 60 464
E-Mail: micro@zeiss.de

www.zeiss.de/micro

Design and specifications are subject to change in the interest of technical development

40-010 e/03.02

NOTES ON THE PDF FILE

VIEW

When paging through the PDF file, as a rule you will see one page on your screen at a time.

If you wish to see two facing pages of a catalog at a time, please activate the "Continuous - Facing Pages" item in the "View" menu of Acrobat Reader.

PRINTING

The pages of the PDF file are sized 210 x 277 mm.

Please mind that your printer may not print the page area from edge to edge.

To avoid picture cropping, please change the print size. We recommend 95%.

The area to be printed is framed by black lines on every page of this PDF file.